

# S-60

## PLANOS

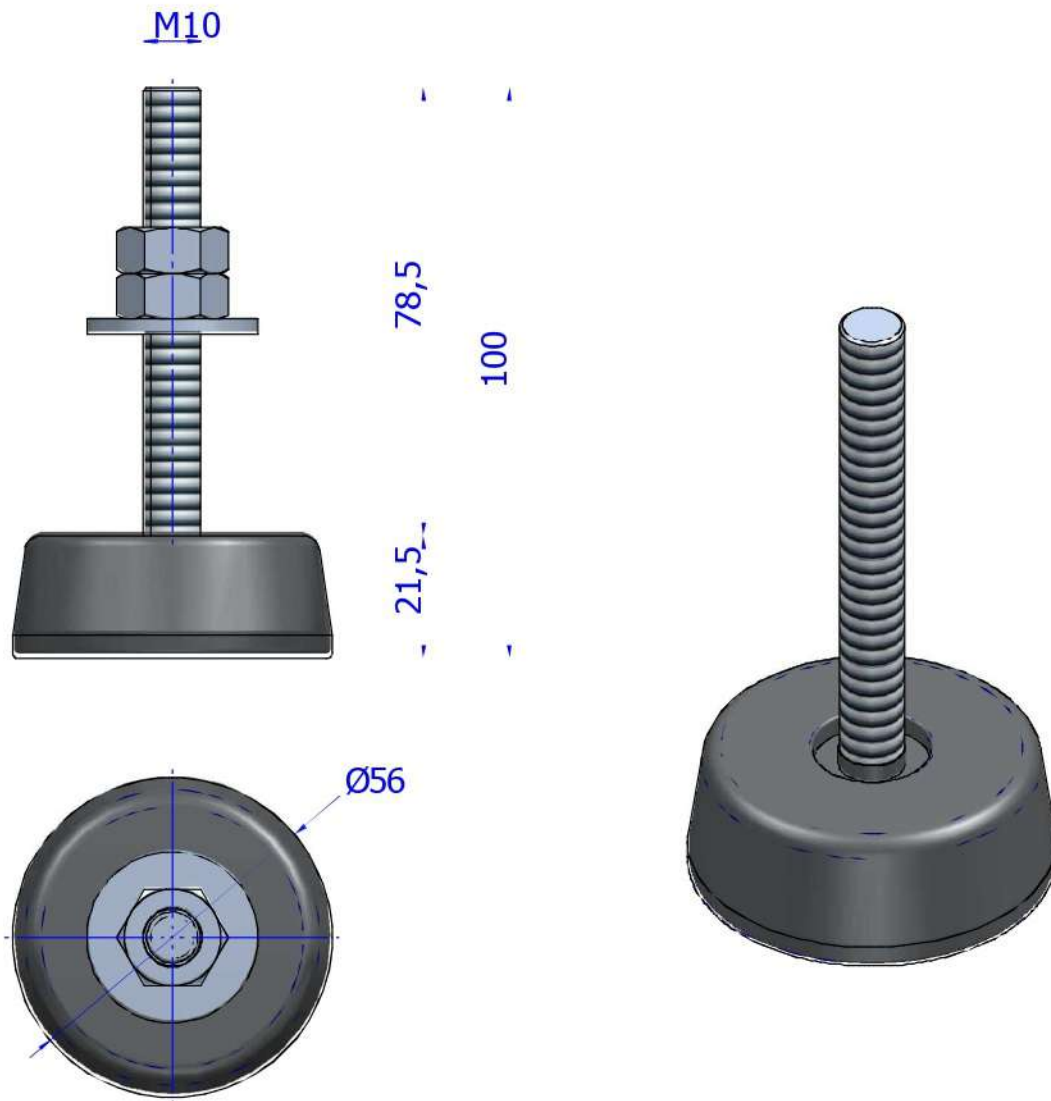

Tipo	Peso (kg)	CARGA (kg MIN)	CARGA (kg MAX)
S-60	0,607	50	150